

Made for
iPod iPhone iPad



ReSound GN

ReSound LiNX 3D™

User guide





Receiver-In-Ear hearing aids

GN Making Life Sound Better

resound.com

Left Hearing Aid		Right Hearing Aid	
Serial number		Serial number	
Model number		Model number	
Receiver type	<input type="checkbox"/> Low Power <input type="checkbox"/> Medium Power <input type="checkbox"/> High Power <input type="checkbox"/> Ultra Power	Receiver type	<input type="checkbox"/> Low Power <input type="checkbox"/> Medium Power <input type="checkbox"/> High Power <input type="checkbox"/> Ultra Power
Receiver tube length	<input type="checkbox"/> 0 <input type="checkbox"/> 1 <input type="checkbox"/> 2 <input type="checkbox"/> 3 <input type="checkbox"/> 4	Receiver tube length	<input type="checkbox"/> 0 <input type="checkbox"/> 1 <input type="checkbox"/> 2 <input type="checkbox"/> 3 <input type="checkbox"/> 4
Battery size	<input type="checkbox"/> 312 <input type="checkbox"/> 13		

Open/ standard fitting:	<input type="checkbox"/> Small <input type="checkbox"/> Medium <input type="checkbox"/> Large	<input type="checkbox"/> Small <input type="checkbox"/> Medium <input type="checkbox"/> Large	<input type="checkbox"/> Tulip	<input type="checkbox"/> Earmould
	Open dome	Power dome	Tulip dome	RIE mould

Programme	Beep	Description
1		
2		
3		
4		

Specific features supported by your hearing system:

- Smart Start on page 13
- Phone Now on page 22
- Telecoil on page 24
- Tinnitus Sound Generator on page 29
- Direct Audio Input on page 26

Hearing aid type designations for models included in this user guide are:

BRIE, FCC ID: X26BRIE, IC: 6941C-BRIE; **VE312**, FCC ID: X26VE312, IC: 6941C-VE312. Please see page 7 for list of models referring to all types.

This device operates in the frequency range of 2.4 GHz - 2.48 GHz. This device includes an RF transmitter that operates in the range of 2.4 GHz - 2.48 GHz.

1 Introduction

Congratulations on the purchase of your new hearing aids. ReSound's innovative sound technology and design, combined with the customized programming selected by your hearing care professional, will make hearing a more enjoyable experience.

Please read this manual carefully in order to wholly benefit from the use of your hearing aids. With proper care, maintenance, and usage, your hearing aids will serve you in better communication for many years.

Ask your hearing care professional if you have any questions.

2 Intended use

Generic air-conduction hearing aids are wearable sound-amplifying devices intended to compensate for impaired hearing. The fundamental operating principle of hearing aids is to receive, amplify, and transfer sound to the eardrum of a hearing-impaired person.

3 Becoming accustomed to amplification

While purchasing a hearing aid is a major step, it is only one step in a process toward more comfortable hearing. Successfully adapting to the amplification your hearing aid provides takes time and consistent use.

You will enjoy more benefits from your ReSound hearing aid by taking the following actions:

- Wear the hearing aid regularly in order to get comfortable with using it.
- It takes time to get used to a hearing aid. It may help to begin by wearing your hearing aid for short periods – even as little as 15 minutes – and then gradually increasing your wearing time. In a way, it is no different from adjusting to contact lenses. Speak to your hearing care professional, who can design a schedule tailored just for you.
- As you get more comfortable with the hearing aid, increase the wearing time and wear your hearing aid in multiple types of listening environments.

It may take as long as several months for your brain to get used to all the “new” sounds around you. Following these suggestions will give your brain time to learn how to interpret amplification and increase the benefits you get from using a ReSound hearing aid.

4 Statement

This device complies with part 15 of the FCC rules and ISED rules.

Operation is subject to the following two conditions:

1. This device may not cause harmful interference.
2. This device must accept any interference received, including interference that may cause undesired operation.



NOTE: This equipment has been tested and found to comply with the limits for a Class B digital device, pursuant to part 15 of the FCC rules and ISED rules. These limits are designed to provide reasonable protection against harmful interference in a residential installation. This equipment generates, uses and can radiate radio frequency energy and, if not installed and used in accordance with the instructions, may cause harmful interference to radio communications. However, there is no guarantee that interference will not occur in a particular installation. If this equipment does cause harmful interference to radio or television reception, which can be determined by turning the equipment off and on, the user is encouraged to try to correct the interference by one or more of the following measures:

- Reorient or relocate the receiving antenna.
- Increase the separation between the equipment and receiver.
- Connect the equipment into an outlet on a circuit different from the one in which the receiver is connected.
- Consult the dealer or an experienced radio/TV technician for help.

Changes or modifications can void the user's authority to operate the equipment.

The products comply with the following regulatory requirements:

- In EU: the device conforms to the Essential Requirements according to Annex I of Council Directive 93/42/EEC for medical devices (MDD) .
- Hereby, ReSound A/S declares that the radio equipment types BRIE and VE312 are in compliance with Directive 2014/53/EU. The full text of the EU declaration of conformity is available at the following internet address: www.declarations.resound.com
- In US: FCC CFR 47 Part 15, subpart C.
- Other identified applicable international regulatory requirements in countries outside the EU and US. Please refer to local country requirements for these areas.
- In Canada: these hearing aids are certified under the rules of ISED.
- Japanese Radio Law and Japanese Telecommunications Business Law Compliance. This device is granted pursuant to the Japanese Radio Law (電波法) and the Japanese telecommunications Business Law (電気通信事業法) This device should not be modified (otherwise the granted designation number will become invalid

Patents: US 7,593,537 US 8,00,849

Mini Receiver In-the-Ear (RIE) hearing aids of type **VE312** with FCC ID: X26VE312, IC number 6941C-VE312 and size **312** battery are available in the following variants:
LT961-DRW, LT761-DRW, LT561-DRW

Receiver-in-the-ear (RIE) hearing aids of type **BRIE** with FCC ID X26BRIE, IC number 6941-BRIE and size **13** battery are available in the following variants:
LT962-DRW, LT762-DRW, LT562-DRW

5 Contents

1	Introduction.....	4	8.2	Using ReSound hearing aids with Smart phone apps	22	Generator (TSG) hearing aid.....	32	19.1	TSG precautions	45	
2	Intended use	4	8.3	Cellular phones	22	9.7	Important notice for prospective sound generator users.....	33	19.2	TSG warning to hearing care professionals	45
3	Becoming accustomed to amplification	5	8.4	Phone Now	22	10	The receiver tube	34	20	Battery warnings.....	47
4	Statement	6	8.4.1	Placement of Phone Now magnets.....	23	11	How to apply domes	34	21	Hearing aid expectations	47
5	Contents	8	8.4.2	Phone Now usage	23	11.1	ReSound domes	34	22	Warning to hearing aid professionals (US Only)	48
6	Descriptions	10	8.5	Telecoil (62-DRW only)	24	11.2	ReSound Tulip domes	35	23	Important notice for prospective hearing aid users (US Only)	48
6.1	Your hearing aid LT61/LT62	10	8.5.1	Tele loop systems	25	12	Wireless accessories.....	36	24	Children with hearing loss (US Only).....	49
6.2	Recognising left and right hearing aid	12	8.5.2	HAC Telephone	25	13	ReSound Assist (Optional)	36	25	Technical Specs Section	50
7	Getting started	13	8.6	Direct Audio Input (optional).....	26	14	Care and maintenance.....	37	25.1	RIE - LP receiver	50
7.1	On/Off function	13	8.6.1	Connecting DAI	27	14.1	Daily maintenance.....	38		RIE - MP receiver	51
7.1.1	Smart Start	13	8.6.2	Disconnecting DAI.....	27	14.2	Cleaning the receiver tubes and domes	38		RIE—HP receiver	52
7.2	Inserting/Replacing the battery	13	8.7	Flight mode (optional)	28	14.3	Cleaning RIE or moulds (does not apply for UP moulds).....	38		RIE—UP receiver	53
7.3	Low battery indicator	14	9	Tinnitus Sound Generator (TSG) module	29	14.4	Changing wax guard for receiver tube.....	39	26	Troubleshooting guide	54
7.3.1	Low battery indicator when paired with wireless accessories only	15	9.1	Intended use for the TSG module	29	15	General warnings.....	40	27	Warranties and repairs	58
7.4	Insert/Remove hearing aid	16	9.2	User instructions for the TSG module	29	16	Using ReSound hearing aids with ReSound apps for smart phones	42	28	Temperature test, transport and storage information	59
7.4.1	Insert earmould	16	9.2.1	Description of the device.....	29	16.1	Intended use of ReSound apps for smart phones:	42			
7.4.2	Remove earmould.....	17	9.2.2	Explanation of how the device functions.....	29	16.2	General precautions	42			
7.4.3	Insert thin tube with dome	17	9.2.3	TSG volume control.....	30	17	Phone Now warnings	43			
7.4.4	Remove thin tube with dome.....	18	9.3	Using TSG with smart phone apps	31	17.1	Phone Now precautions	43			
7.4.5	Sports lock	18	9.4	The scientific concepts that form the basis for the device.....	31	18	Important points for FM.....	44			
7.5	Operation of the hearing aid	18	9.5	Technical Specifications.....	31	19	Tinnitus Sound Generator (TSG) warnings... ..	45			
7.5.1	Push button and Multi-function button	18	9.5.1	Audio signal technology	31						
8	Telephone use	21	9.5.2	Available sounds.....	32						
8.1	Using ReSound Smart Hearing Aids with iPhone®, iPad®, and iPod touch® (optional)	21	9.6	Prescription use of a Tinnitus Sound							

6 Descriptions

6.1 Your hearing aid – LT 61 / LT 62

1. Receiver tube
2. Receiver Open Dome
3. Receiver Tulip Dome
4. Receiver Power Dome
5. RIE mould
6. Sports lock
7. Battery door
8. Receiver
9. Push button (only for LT 61 models)
10. Multi-function button
11. LP receiver tube
12. MP receiver tube
13. HP receiver tube
14. UP Receiver/Mould
15. Model, and serial number (in battery chamber)
16. Direct audio input

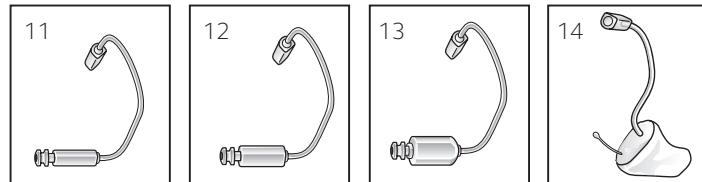
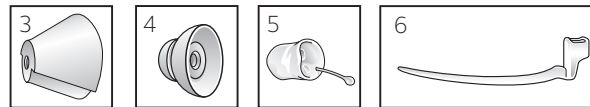
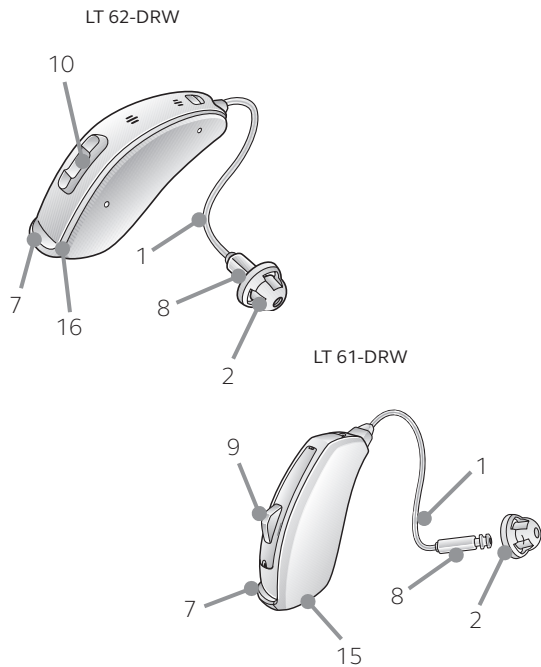

6.2 Recognising left and right hearing aid

If you have two hearing aids, they may be tuned differently. One for your left ear, the other for your right. Do not swap them. Please pay attention to this when cleaning, storing and inserting the hearing aids.

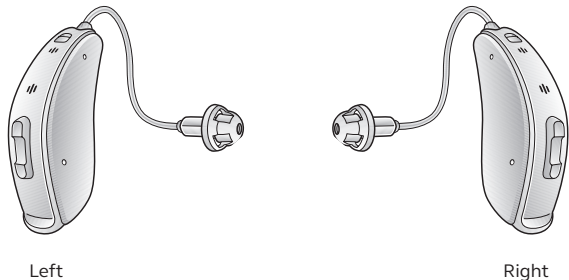

You might want to ask your hearing care practitioner to mark your hearing aids with a coloured Left and Right indication: Left is blue and Right is red.

7 Getting started

Once you have placed the hearing aids on your ears, you can turn them on. The hearing aid always starts in programme 1 and with the pre-set volume.

7.1 On/Off function

1. Close the battery door to turn on the hearing aid in programme 1 (one).
2. Open the battery door to turn off the hearing aid. Use your fingernail to pull it open.

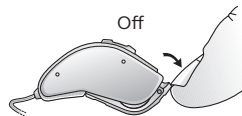
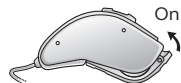

7.1.1 Smart Start

Smart Start delays the time before the hearing aid turns on after you close the battery door. With Smart Start, you will hear a beep (♫♫♫ etc.) for each second of the delay period (5 or 10 seconds delay).

If you do not want to turn on the hearing aids prior to placing them on your ear, ask your hearing care professional to de-activate Smart Start.

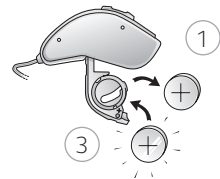

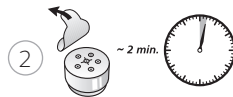

7.2 Inserting/Replacing the battery

1. Open the battery door completely by using your fingernail. Remove the used battery if present.
2. Prepare the new battery (please refer to page 2 for information on appropriate battery type/size for your hearing aid). Remove the protective foil to activate the battery.
3. Wait for 2 minutes before inserting the battery into the hearing aid.



4. Insert the new battery with the positive side in the correct position. Always insert the battery in the door: never directly into the hearing aid.
5. Gently close the battery door.

-  1. Always use new Zinc-Air batteries that have a minimum remaining shelf life of 1 year.
2. Whenever the hearing aids are not in use, remember to turn them off to avoid unnecessary battery consumption.
3. At night, switch off the hearing aid and open the battery door completely to allow moisture to evaporate and prolong the hearing aid's lifespan.
4. If the hearing aid is experiencing frequent loss of connection to ReSound wireless accessories, contact your hearing care professional for a list of low impedance batteries.

 **WARNING:** Batteries contain dangerous substances and should be disposed of carefully in the interest of your safety and for the environment. Also, keep batteries away from pets, children and mentally disabled persons.

7.3 Low battery indicator



The hearing aid will reduce amplification and play a melody if battery power gets too low. This signal will recur every 15 minutes until the hearing aid automatically switches off.

 **NOTE:** Keep spare batteries on hand.

7.3.1 Low battery indicator when paired with wireless accessories only

The batteries drain faster when you use wireless functionalities like direct streaming from your iPhone or streaming sound from your TV with our TV Streamer. When the batteries deplete, the support of some ReSound wireless accessories shut down. Full functionality returns when you insert a new battery.

The table below shows how the functionality decreases with the depletion of the batteries.

Battery level	Signal	Hearing aid	Remote Control	Streaming
Fully charged		✓	✓	✓
Low		✓	✓	x
Depleted (change battery)		✓	x	x

7.4 Insert/Remove hearing aid

For comfort, always turn off your hearing aids before you insert or remove them.

7.4.1 Insert earmould

1. Hold the earmould between your thumb and index finger and position its sound outlet in your ear canal.
2. Slide the earmould all the way into your ear with a gentle, twisting movement.
3. Move the earmould up and down and gently press to place it correctly in the ear. Opening and closing your mouth can ease insertion.
4. Make sure the hearing aid sits firmly behind the ear.

By experimenting, you may discover an easier method. With proper insertion, hearing aids should fit snugly but comfortably.



NOTE: It may be helpful to pull your ear up and outward with your opposite hand during insertion.



CAUTION: Never attempt to modify the shape of the hearing aid, earmoulds, or tubing yourself.

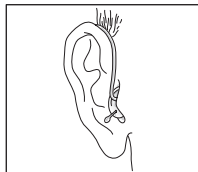
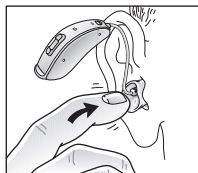
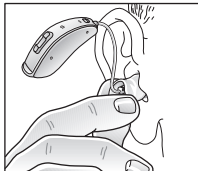

7.4.2 Remove earmould

1. Lift the hearing aid from behind the ear. For a moment, let it hang beside your ear.
2. Gently pull the removal cord (not the hearing aid or the tubing) to pull the hearing aid from the ear.



NOTE: For thin tube custom earmoulds, grasp the removal cord and pull the earmould outward.

3. Remove the earmould completely by gently twisting it.

7.4.3 Insert thin tube with dome

1. Hang the hearing aid over the top of the ear.
2. Hold the thin tube where it bends and gently place/push the dome into the ear canal. Push the dome far enough into the ear canal so that the thin tube lies flush with the head (check with a mirror).

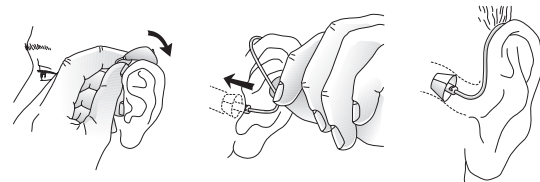

NOTE: To avoid whistling, it is important that the tube and the dome fit correctly into your ear. For other possible reasons, check with the Troubleshooting guide.



CAUTION: Never attempt to bend or modify the shape of the thin tube.

7.4.4 Remove thin tube with dome

1. Hold the thin tube with your thumb and forefinger and remove the tube.

7.4.5 Sports lock

Your hearing care professional will apply and adjust the Sports lock.

7.5 Operation of the hearing aid

7.5.1 Push button and Multi-function button

If you have a hearing aid with a push button or multi-function button, this will allow you to use up to four different listening programmes, each of them suitable for certain situations.

1. Tap the push button to switch between programmes.
2. You will then hear one or more beeps. The number of beeps indicates which programme you have selected (one beep = programme one, two beeps = programme two, etc.).
3. When you turn the hearing aids off and then back on, they always return to the default setting (programme one and pre-set volume).

It should not be necessary to control the volume manually. However, in addition to controlling listening programmes, the multi-function button (62-DRW only) provides you with the ability to adjust the amplification to your liking.

The multi-function button is designed to change the volume or listening programmes of the hearing aid, based on different ways it is pressed.

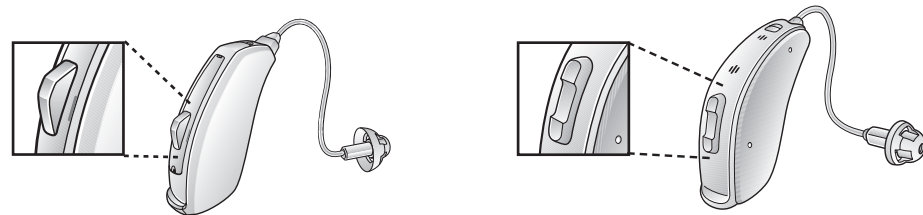

Programme button (61 models only)

Multi-function button (62 models only)

If necessary, your hearing care practitioner can change the default settings for the multi-function button and fill in the following table to indicate the new settings:

Multi-function button action	Default setting	New Setting
Short press up	Increases volume	
Short press down	Decreases volume	
Long press up (3 seconds)	Changes programmes	
Long press down (3 seconds)	Activates streaming	

i NOTE: If you have two hearing aids with the Synchronised Push Button enabled, programme changes to one hearing aid automatically repeats in the second hearing aid. When you change a programme in one hearing aid, it responds with one or more beeps. The same number of confirmation beeps in the second aid follow. This Synchronised Push Button can also be configured to allow one side to control volume increase and the other side to control volume decrease. The volume changes to one hearing aid are repeated on the other side to keep the levels the same.

8 Telephone use

Your hearing aid allows you to use the telephone as you ordinarily do. Finding the optimal position for holding a telephone may require practice. One or more of the following suggestions may be helpful:

1. Hold the telephone up to your ear.
2. Hold the telephone towards the top of the ear (closer to where the microphones are).
3. If whistling occurs, it may take a few seconds of holding the telephone in the same position before the hearing aid eliminates the feedback.
4. Whistling may stop by holding the telephone slightly away from the ear.



i NOTE: Depending on your individual needs, your hearing care professional may activate a programme specifically for telephone use.

8.1 Using ReSound Smart Hearing Aids with iPhone®, iPad®, and iPod touch® (optional)

ReSound LiNX 3D hearing aids are Made for iPhone®, and allow for direct communication and control with an iPhone®, iPad®, or iPod touch®.

i NOTE: For assistance with pairing and using these products with your ReSound LiNX 3D device, please contact your hearing care professional.

8.2 Using ReSound hearing aids with smart phone apps

Use with smart phone apps:

- Notifications of app updates should not be disabled, and it is recommended that the user installs all updates to ensure that the app will function correctly and will be kept up to date.
- The app must only be used with ReSound devices for which it is intended, and ReSound take no responsibility if the app is used with other devices.
- If you would like a printed version of the user guide for a smart phone app, please consult customer support or go to our website at www.resound.com/support.

8.3 Cellular phones

Your hearing aid complies with the most stringent Standards of International Electromagnetic Compatibility. However, not all cell phones are hearing aid compatible (HAC).

Any degree of disturbance can be due to the nature of your particular cellular phone or of your wireless telephone service provider.

 **NOTE:** If you find it difficult to obtain a good result while using your cellular phone, your hearing care professional will be able to give you advice on available wireless accessories to enhance listening capabilities.

8.4 Phone Now

The Phone Now function automatically switches your present listening programme to your telephone programme when a telephone receiver, equipped with a magnet, is close to your ear. When you remove

the telephone receiver from your ear, the hearing aid automatically returns to the previous listening programme.

8.4.1 Placement of Phone Now magnets

Place Phone Now magnet on your telephone receiver to allow operation of the Phone Now function. In order to place Phone Now magnet properly:

1. Clean the telephone receiver thoroughly.
2. Hold the telephone vertically, in a position similar to when making a telephone call.
3. Place the magnets just below the telephone receiver. Make sure not to cover the microphone openings. If necessary, move the magnet to another position to improve ease of use and comfort while speaking.

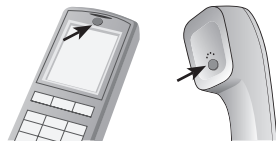

 **NOTE:** If you are not satisfied with the strength of Phone Now, you can reposition the Phone Now magnet or add additional Phone Now magnets.
NOTE: Prior to placing the magnet on the telephone or cell phone, use a recommended cleaning agent to clean the telephone.

8.4.2 Phone Now usage

1. Use your telephone in a normal manner.
2. A short melody indicates that the Phone Now feature has automatically switched on the telephone programme.

i **NOTE:** Initially, you may need to move the telephone receiver slightly to find the best position for reliable Phone Now activation and good hearing on the telephone.

If you have two hearing aids with enabled Comfort Phone functionality, the hearing aid on the non phone ear automatically reduces the volume.

8.5 Telecoil (62-DRW only)

Your hearing aid may be equipped with a telecoil. The Telecoil programme may help to improve speech understanding with Hearing Aid Compatible telephones and in theatres, cinemas, houses of worship etc. that has tele-loop installed.

The telecoil cannot work without a tele-loop (a.k.a. induction-loop) or a Hearing Aid Compatible (HAC) telephone. When you switch on the Telecoil programme, your hearing aids pick up signals from the tele-loop or HAC telephone.

i **NOTE:** If you are having trouble hearing with the tele-loop, ask your hearing care professional to adjust the programme.

NOTE: If there is no sound from the hearing aids in a tele-loop system and an active Telecoil programme, the tele-loop system may not be turned on or is not operating correctly.

8.5.1 Tele loop systems

To use tele loop systems, follow these steps:

1. Switch your hearing aid to the Telecoil programme.
2. Find a good spot. Reception is not clear in all locations; it depends on the induction loop. Look for signs or find another spot to sit.
3. If needed, adjust the volume.
4. When you leave, switch to programme 1.

8.5.2 HAC Telephone

The telecoil picks up the HAC telephone's telecoil signal and converts it to sound.

To use the HAC telephone, follow these steps:

1. Switch your hearing aid to the Telecoil programme.
2. Pick up the telephone and place a call or answer a call.
3. Hold the telephone behind your ear – close to the hearing aid, and tilt it slightly outwards.
4. Listen to the dialling tone and move the telephone to get the best reception.
5. If needed, adjust the volume.
6. When you hang up, switch to programme 1.

i **NOTE:** If the phone has a poor telecoil signal, try to use a microphone programme. To avoid whistling, do not hold the handset too tightly against your ear.

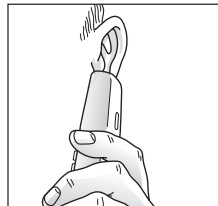
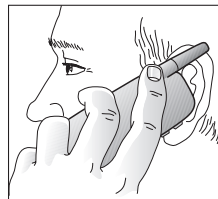

8.6 Direct Audio Input (optional)

Your hearing aid is equipped with a Direct Audio Input facility. Direct Audio Input allows direct connection of sound sources, a radio, television or even school equipment, to your hearing aid. Often, this will improve sound quality.



Audio shoe

The sound source transmits to your hearing aid via a cable and a click-on device.

The hearing aid automatically detects the Direct Audio Input (DAI) source. The DAI supports the systems for wireless use as well.

Your hearing aid professional can adjust your hearing aids to fit the mix between the digital audio input and the microphones on your hearing aids. You may, e.g. select to lower the ambient sounds and amplify the sounds from the transmitter.

This accessory connects to the bottom of the hearing aids. Once clicked into place, the hearing aids automatically close the microphones and switch to DAI.

8.6.1 Connecting DAI

1. Align the tip of the DAI click-on adaptor with the groove just above the battery door and below the model number.
2. Once in place, move the DAI click-on adaptor in the direction of the battery door.
3. Gently click the DAI click-on adaptor onto the hearing aid.

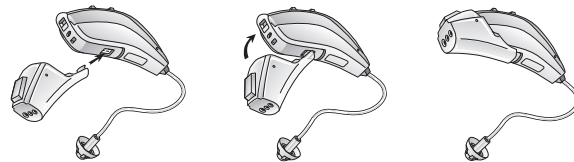

8.6.2 Disconnecting DAI

1. Press and hold the button on the front side of the DAI click-on adaptor.
2. Gently remove the DAI click-on adaptor from the hearing aid.

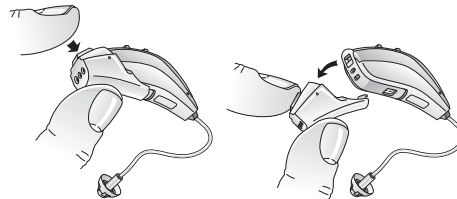

8.7 Flight mode (optional)

 **WARNING:** When boarding a flight or entering an area where RF transmitters are prohibited, wireless functionality must be deactivated.

Your ReSound LiNX 3D hearing aid allows you to control it from your smart phone or ReSound Remote Control. However, in some areas you are requested to turn off wireless communication.

Follow these steps to turn off wireless mode:

1. For each hearing aid, open and close (open-close, open-close, open-close) the battery door three times within a 10-second period.
2. Double-dings for ten seconds (🎵🎵🎵 etc.) indicate that your hearing aid is in Flight mode.

Follow these steps to activate wireless mode:

1. For each hearing aid, open and close the battery door once.
2. Your hearing aids are in wireless mode after 10 seconds.

 **NOTE:** Both hearing aids must be set in Flight mode - even with synchronisation enabled.

NOTE: It is important to wait an additional 15 seconds after wireless function resumes before opening and closing the battery door again for any reason. Flight mode will resume if you open and close the battery door during this 15-second window.

9 Tinnitus Sound Generator (TSG) module

9.1 Intended use for the TSG module

Your ReSound hearing aid includes the Tinnitus Sound Generator function, a tool for generating sounds to be used in tinnitus management programmes to relieve suffering from tinnitus.

The Tinnitus Sound Generator can generate sounds adjusted to the specific therapeutic needs and your personal preference as determined by your doctor, audiologist, or hearing care professional. Depending on the selected hearing aid programme and the environment you are in, you will sometimes hear the therapeutic sound resembling a continuous or fluctuating humming.

9.2 User instructions for the TSG module

9.2.1 Description of the device

The Tinnitus Sound Generator (TSG) Module is a software tool that generates sounds to be used in tinnitus management programmes to relieve suffering from tinnitus.

9.2.2 Explanation of how the device functions

The TSG module is a frequency and amplitude shaped white-noise generator. Noise signal level and frequency characteristics can be adjusted to the specific therapeutic needs as determined by your doctor, audiologist or hearing care professional.

Your doctor, audiologist or hearing care professional can modulate the generated noise with the purpose of making it more pleasant. The noise can then resemble, for example, crashing waves on a shore.

Modulation level and speed can also be configured to your likes and needs. An additional feature can be enabled by your hearing care professional that allows you to select predefined sounds that simulate sounds from nature, such as breaking waves or running water.

If you have two wireless hearing aids that support ear-to-ear synchronisation this functionality can be enabled by your hearing care professional. This will cause the Tinnitus Sound Generator to synchronise the sound in both hearing aids.

If your tinnitus troubles you only in quiet environments, your doctor, audiologist or hearing care professional can set the TSG Module so that it becomes audible exclusively in such surroundings. The overall sound level can be adjusted via an optional volume control. Your doctor, audiologist or hearing care professional will review with you the need for having such a control.

For hearing aids where ear to ear synchronisation is enabled your hearing care professional can also enable environmental monitoring synchronisation so that the TSG noise level is automatically adjusted simultaneously in both hearing aids dependent on the background sound level. Additionally if the hearing aid has a volume control then the background noise level monitored by the hearing aid and the volume control can be used simultaneously to adjust the generated noise level in both hearing aids.

9.2.3 TSG volume control

The sound generator is set to a specific loudness level by the hearing care professional. When switching the sound generator on, the volume will have this optimal setting. Therefore, it might not be necessary to control the volume (loudness) manually. However, the volume control provides the ability to adjust the volume, or amount of stimulus, to the liking of the user.

9.3 Using TSG with smart phone apps

The Tinnitus Sound Generator control via hearing aid push buttons can be enhanced with wireless control from a TSG control app on a smart phone or mobile device. This functionality is available in supported hearing aids when a hearing care professional has enabled the TSG functionality during fitting of the hearing aid.

To use smart phone apps the hearing aid must be connected with the smart phone or mobile device.

9.4 The scientific concepts that form the basis for the device

The TSG module provides sound enrichment with the aim of surrounding the tinnitus sound with a neutral sound, which is easily ignored. Sound enrichment is an important component of most approaches to tinnitus management, such as Tinnitus Retraining Therapy (TRT). To assist habituation to tinnitus, this needs to be audible. The ideal level of the TSG module, therefore, should be set so that it starts to blend with the tinnitus, and so that you can hear both your tinnitus as well as the sound used.

In a majority of instances, the TSG module can also be set to mask the tinnitus sound, so to provide temporary relief by introducing a more pleasant and controllable sound source.

9.5 Technical Specifications

9.5.1 Audio signal technology

Digital

9.5.2 Available sounds

White noise signal which can be shaped with the following configurations:

The white noise signal can be modulated in amplitude with an attenuation depth of up to 14dB.

High-pass filter	Low-pass filter
500 Hz	2000 Hz
750 Hz	3000 Hz
1000 Hz	4000 Hz
1500 Hz	5000 Hz
2000 Hz	6000 Hz

9.6 Prescription use of a Tinnitus Sound Generator (TSG) hearing aid

The TSG module should be used as prescribed by your doctor, audiologist or hearing care professional. In order to avoid permanent hearing damages, the maximum daily usage depends on the level of the generated sound.

Should you develop any side effects from using the sound generator, such as dizziness, nausea, headaches, perceived decrease in auditory function or increase in tinnitus perception, you should discontinue use of the sound generator and seek medical evaluation.

The target population is primarily the adult population over 18 years of age. This product may also be used with children 5 years of age or older. However, children and physically or mentally disabled users will require training by a doctor, audiologist, hearing care professional or the guardian for the insertion and removal of the hearing aid containing the TSG module.

9.7 Important notice for prospective sound generator users

A tinnitus masker is an electronic device intended to generate noise of sufficient intensity and bandwidth to mask internal noises. It is also used as an aid in hearing external noises and speech.

Good health practice requires that a person with a tinnitus condition have a medical evaluation by a licensed physician (preferably a physician who specializes in diseases of the ear) before using a sound generator. Licensed physicians who specialize in diseases of the ear are often referred to as otolaryngologists, otologists or otorhinolaryngologists.

The purpose of medical evaluation is to assure that all medically treatable conditions that may affect tinnitus are identified and treated before the sound generator instrument is used.

The sound generator instrument is a tool to generate sounds to be used with appropriate counselling and/or in a tinnitus management programme to relieve patients suffering from tinnitus.

10 The receiver tube

The receiver tube contains the wiring to the receiver, which delivers the sound to the ear canal. It is important that the receiver tube and the receiver dome/RIE mould fits correctly in your ear. If the receiver tube or the receiver dome/RIE mould irritates your ear in any way and prevents you from wearing your hearing aid, please contact your hearing care professional.

You should never attempt to modify the shape of the receiver tube yourself. The receiver tube and the receiver dome/RIE mould should be cleaned regularly.

Please see cleaning instructions in chapter 14.2 – 14.4.

11 How to apply domes

It is recommended that your hearing care professional shows you how to change the domes, because incorrect dome replacement could result in the dome being left in the ear when you remove the hearing aid.

11.1 ReSound domes

Follow these steps to mount domes:

1. Push the new dome over the ribs flange on the thin tube.
2. Make sure that the new dome is properly and securely mounted.

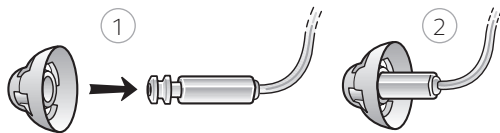

11.2 ReSound Tulip domes

The Tulip domes are mounted in a similar manner to the ordinary domes, but a few extra steps are required. The Tulip domes consist of two “petals”.

Follow these steps to mount domes:

1. Push the largest petal away from the thin tube using a finger. This bends the petal forward.
2. Push the new tulip dome over the flange.
3. Then push the largest petal backwards, and it will be placed on top of the smaller petal.

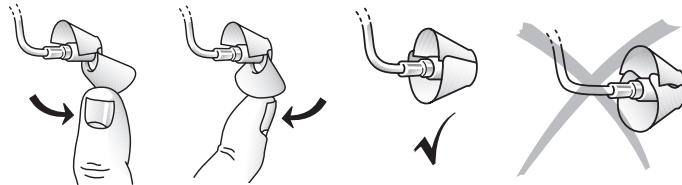

NOTE: It is important to note that the largest petal is the outermost petal.

4. Make sure that the new dome is properly and securely mounted.

12 Wireless accessories

With ReSound wireless accessories, you can stream sound from your TV or music player directly to your ReSound hearing aids and you can also control them without wearing an intermediary device around your neck.

Ask your hearing care professional for more information on the range of ReSound wireless accessories.

13 ReSound Assist (Optional)

If you sign up to use the ReSound Assist service available with your hearing aids, you can allow your hearing aids to be adjusted remotely without even having to travel from where you are at the moment. This allows you to experience unprecedented freedom and flexibility:

1. Request assistance remotely to adjust your hearing aids to be a better fit for you
Ask your hearing care professional for assistance or request adjustments to programs while installing the changes at your convenience – wherever you are
2. Keep your hearing aid up to date with the latest software to ensure the best performance possible
Updates to the hearing aid software available for install at your convenience

 **NOTE:** Your hearing aids shut down during the install and update process. For optimum performance, make sure the hearing aids are connected to the ReSound Smart 3D™ app and placed close to the iPhone or Android smart phone before applying the changes.

Your hearing care professional will gladly provide information regarding ReSound Assist and how it works with the ReSound Smart 3D app.

Ask your hearing care professional for more information.

14 Care and maintenance

Please follow the instructions below to have the best user experience and to prolong the durability of your hearing aids:

3. Keep your hearing aid clean and dry. Wipe the case with a soft cloth or tissue after use to remove grease or moisture. Do not use water or solvents, as these can damage the hearing aid(s).
4. Never immerse hearing aids in water or other liquids, as liquids may cause permanent damage to the hearing aids.
5. Avoid rough handling of hearing aids or dropping them on hard surfaces or floors.
6. Do not leave hearing aids in or near direct heat or sunlight, such as in a hot, parked car, as excessive heat can cause damage or deform the casing.
7. Do not wear your hearing aid while showering, swimming, in heavy rain or in a moist atmosphere such as a steam bath or sauna.
8. If your hearing aid does get wet, or if it has been exposed to high humidity or perspiration, it should be left to dry out overnight with the battery out and the battery door open. It is also a good idea to put the hearing aid and battery in a sealed container together with a drying agent (desiccator) overnight. Do not use the aid until it is completely dry. Consult your hearing care professional as to which drying agent to use.
9. Remove your hearing aid when applying cosmetics, perfume, aftershave, hair spray, and suntan lotion. These might get into the aid and cause damage.

14.1 Daily maintenance

It is important to keep your hearing aid clean and dry. On a daily basis, clean the hearing aids using a soft cloth or tissue. In order to avoid damage due to humidity or excessive perspiration, the use of a drying kit is recommended.

14.2 Cleaning the receiver tubes and domes

The receiver tube and the receiver dome should be cleaned regularly. Use a damp cloth to clean the receiver tube and receiver dome on the outside. Do not use water when you are cleaning the receiver tubes or the receiver domes. This process is also used to clean the UP receiver mould. Please see chapter 15.4 for how to change the wax guard filter.

 **NOTE:** If the components get stiff, brittle, or discoloured, ask your hearing care professional for a replacement.

14.3 Cleaning RIE or moulds (does not apply for UP moulds)

1. Separate the mould from the receiver tube.
2. Clean the RIE mould using a mild soap, and rinse with lukewarm water.
3. After cleaning, dry RIE moulds thoroughly and remove any residual water and debris utilising an air bulb.

 **NOTE:** Earmould tubing may become stiff, brittle, or discoloured over time. Contact your hearing care professional regarding tube changes.

14.4 Changing wax guard for receiver tube

For changing Cerustop (white) wax filters, the following steps are needed:

1. To remove the old wax guard, insert the removal side of the wax guard tool into the used wax guard so that the shaft of the tool is touching the rim of the wax guard. Slowly pull the wax guard straight out.
2. To insert the new wax guard, gently press the replacement side of the wax guard tool straight into the hole of the sound outlet until the outer ring lies flush with the outside of the receiver. Pull the tool straight out -the new wax guard will remain in place.

15 General warnings

1. Consult a hearing care professional if you think there may be a foreign object in your ear canal, if you experience skin irritation, or if excessive earwax accumulates with the use of the hearing aid.
2. Different types of radiation, from e.g. NMR, MRI, or CT scanners, may damage hearing aids. It is recommended not to wear hearing aids during these or other similar procedures. Other types of radiation, such as burglar alarms, room surveillance systems, radio equipment, mobile telephones, contain less energy and will not damage hearing aids. However, they have the potential to momentarily affect the sound quality or temporarily create undesired sounds from hearing aids.
3. Do not wear hearing aids in mines, oil fields, or other explosive areas unless those areas are certified for hearing aid use.
4. Do not allow others to use your hearing aids. This may cause damage to the hearing aids or to the hearing of the other individual.
5. Hearing Aid usage by children or mentally disabled persons should be supervised at all times to ensure their safety. The hearing aid contains small parts that could be swallowed by children. Please be mindful not to leave children unsupervised with this hearing aid.
6. Hearing aids should be used only as prescribed by your hearing care professional. Incorrect use may result in hearing loss.
7. Warning to hearing care professionals: Special care should be exercised in selecting and fitting hearing aids with maximum sound pressure level that exceeds 132dB SPL with an IEC 60711:1981 occluded ear simulator. There may be a risk of impairment of the remaining hearing.
8. Be careful when boarding flights to deactivate the wireless functionality. Turn off your wireless functionality by using the flight mode in areas where radio frequency emission is prohibited.
9. If device is broken, do not use.

10. External devices connected to the electrical input must be safe according to the requirements of IEC 60601-1, IEC 60065, or IEC 60950-1 , as appropriate (wired connection, for example HI-PRO), SpeedLink).



1. ReSound wireless devices include a RF transmitter that operates in the range of 2.4 GHz - 2.48 GHz.
2. Nominal RF output power transmitted is 0 dBm.
3. For use of wireless functionality only use ReSound accessories. For further guidance regarding e.g. pairing, please refer to the user guide of the relevant ReSound wireless accessory.

16 Using ReSound hearing aids with ReSound apps for smart phones

16.1 Intended use of ReSound apps for smart phones:

ReSound smart phone apps are intended to be used with ReSound wireless hearing aids. ReSound smart phone apps send and receive signals from the ReSound wireless hearing aids via smart phones for which the apps have been developed.

16.2 General precautions

1. When wireless function is activated, the device uses low-powered digitally coded transmissions in order to communicate with other wireless devices. Although unlikely, nearby electronic devices may be affected. In that case, move the hearing aid away from the affected electronic device.
2. When using wireless functionality and the devices are affected by electromagnetic interference, move away from the source.
3. Use only original ReSound consumables e.g. tubes and domes.
4. Only connect ReSound hearing aids to ReSound wireless accessories intended and qualified to be used with ReSound hearing aids.

17 Phone Now warnings

1. Keep magnets out of reach of pets, children and people with mental disabilities. If a magnet is swallowed, please seek advice from a medical practitioner.
2. The magnet may affect some medical devices or electronic systems. The manufacturer of any magnetically sensitive devices (e.g. pacemakers) should advise you regarding appropriate safety precautions when using your hearing aid and magnet in close proximity to the medical device or electronic system in question. If the manufacturer cannot issue a statement, we recommend keeping the magnet or a telephone equipped with the magnet 30 cm (12") away from magnetically sensitive devices (e.g. pacemakers).

17.1 Phone Now precautions

1. High distortion during dialling or phoning may mean that the magnet is not in the optimal position relative to the telephone receiver. To avoid the issue, please move the magnet to another place on the telephone receiver.
2. Only use magnets supplied by ReSound.

18 Important points for FM

1. Do not use two transmitters on the same FM channel.
2. Do not use water or fluids for cleaning the FM shoe.
3. Do not use an FM transmitter in locations where it is forbidden to use electronic devices, for instance in airplanes.
4. Be aware that FM signals might also be picked up and overheard by other receivers.
5. Before using the system in another country, contact your hearing care professional to make sure your radio channel is permitted in that country.
6. Your FM shoe and transmitter may only be repaired by an authorized service centre.

19 Tinnitus Sound Generator (TSG) warnings

1. Sound generators can be dangerous if improperly used.
2. Sound generators should be used only as advised by your doctor, audiologist, or hearing care professional.
3. Sound generators are not toys and should be kept out of reach of anyone who might cause themselves injury (especially children and pets).

19.1 TSG precautions

1. Should the user develop any side effects from using the sound generator, such as dizziness, nausea, headaches, perceived decrease in auditory function or increase in tinnitus perception, the user should discontinue use of the sound generator and seek medical evaluation.
2. Children and physically or mentally challenged users will require guardian supervision while wearing the TSG hearing aid.
3. The volume control is an optional feature in the TSG module used for adjusting the sound generator output level. To prevent unintended usage by paediatric or physically or mentally challenged users, the volume control must, if enabled, be configured to only provide a decrease of the sound generator output level.

19.2 TSG warning to hearing care professionals

A hearing care professional should advise a prospective sound generator user to consult promptly with a licensed physician (preferably an ear specialist) before getting a sound generator if the hearing care professional determines through inquiry, actual observation, or review of any other available information

concerning the prospective user that the prospective user has any of the following conditions:

1. Visible congenital or traumatic deformity of the ear.
2. History of active drainage from the ear within the previous 90 days.
3. History of sudden or rapidly progressive hearing loss within the previous 90 days.
4. Acute or chronic dizziness.
5. Unilateral hearing loss of sudden or recent onset within the previous 90 days.
6. Audiometric air-bone gap equal to or greater than 15dB at 500 hertz (Hz), 1000 Hz, and 2000 Hz.
7. Visible evidence of significant cerumen accumulation or a foreign body in the ear canal.
8. Pain or discomfort in the ear.

 **CAUTION:** The maximum output of the sound generator falls into the range that can cause hearing loss according to OSHA regulations. In accordance with NIOSH recommendations, the user should not use the sound generator for more than eight (8) hours a day when set to a level of 85 dB SPL or above. When the sound generator is set to levels of 90 dB SPL or above, the user should not use the sound generator for more than two (2) hours per day. In no case should the sound generator be worn at uncomfortable levels.

20 Battery warnings

Batteries contain dangerous substances and should be disposed of carefully in the interest of your safety and for the environment. Please note:

1. Keep batteries away from pets, children and mentally challenged persons.
2. DO NOT place batteries in your mouth. Consult a physician immediately if a battery has been swallowed, as they can be harmful to your health.
3. Do not attempt to recharge batteries (Zinc Air) which are not specifically designated as rechargeable because they may leak or explode.
4. DO NOT attempt to dispose of batteries by burning them.
5. Used batteries are harmful to the environment. Please dispose of them according to local regulations or return them to your hearing care professional.
6. Remove the batteries to prevent leakage when the hearing aids are not in use for an extended period of time.

21 Hearing aid expectations

A hearing aid will not restore normal hearing and will not prevent or improve a hearing impairment resulting from organic conditions. Consistent use of the hearing aid is recommended. In most cases, infrequent use does not permit you to attain full benefit from it.

The use of a hearing aid is only part of hearing rehabilitation and may need to be supplemented by auditory training and instructions in lip-reading.

22 Warning to hearing aid professionals (US Only)

A hearing care professional should advise a prospective hearing aid user to consult promptly with a licensed physician (preferably an ear specialist) before dispensing a hearing aid if the hearing aid professional determines through inquiry, actual observation, or review of any other available information concerning the prospective user, that the prospective user has any of the following conditions:

1. Visible congenital or traumatic deformity of the ear.
2. History of active drainage from the ear within the previous 90 days.
3. History of sudden or rapidly progressive hearing loss within the previous 90 days.
4. Acute or chronic dizziness.
5. Unilateral hearing loss of sudden or recent onset within the previous 90 days.
6. Audiometric air-bone gap equal to or greater than 15 decibels at 500 hertz (Hz), 1,000 Hz, and 2,000 Hz.
7. Visible evidence of significant cerumen accumulation or a foreign body in the ear canal.
8. Pain or discomfort in the ear.

23 Important notice for prospective hearing aid users (US Only)

Good health practice requires that a person with a hearing loss have a medical evaluation by a licensed physician (preferably a physician who specializes in diseases of the ear) before purchasing a hearing aid. Licensed physicians who specialize in diseases of the ear are often referred to as otolaryngologists, otologists or otorhinolaryngologists. The purpose of medical evaluation is to assure that all medically treatable conditions that may affect hearing are identified and treated before the hearing aid is purchased.

Following the medical evaluation, the physician will give you a written statement that states that your hearing loss has been medically evaluated and that you may be considered a candidate for a hearing aid. The physician will refer you to an audiologist or a hearing care professional, as appropriate, for a hearing aid evaluation. The audiologist or hearing care professional will conduct a hearing aid evaluation to assess your ability to hear with and without a hearing aid. The hearing aid evaluation will enable the audiologist or hearing care professional to select and fit a hearing aid to your individual needs. If you have reservations about your ability to adapt to amplification, you should inquire about the availability of a trial-rental or purchase-option programme. Many hearing care professionals now offer programmes that permit you to wear a hearing aid for a period of time for a nominal fee after which you may decide if you want to purchase the hearing aid.

Federal law restricts the sale of hearing aids to those individuals who have obtained a medical evaluation from a licensed physician. Federal law permits a fully informed adult to sign a waiver statement declining the medical evaluation for religious or personal beliefs that preclude consultation with a physician. The exercise of such a waiver is not in your best health interest and its use is strongly discouraged.

24 Children with hearing loss (US Only)

In addition to seeing a physician for a medical evaluation, a child with a hearing loss should be directed to an audiologist for evaluation and rehabilitation since hearing loss may cause problems in language development and the educational and social growth of a child. An audiologist is qualified by training and experience to assist in the evaluation and rehabilitation of a child with a hearing loss.

25 Technical specifications

25.1 RIE - LP receiver

Models: LT962-DRW, LT762-DRW, LT562-DRW
LT961-DRW, LT761-DRW, LT561-DRW

Reference test gain (60 dB SPL input)	HFA	31	dB
Full-on gain (50 dB SPL Input)	Max	52	dB
	HFA	43	dB
Maximum output (90 dB SPL input)	Max	113	dB SPL
	HFA	108	dB SPL
Total harmonic distortion	500 Hz	0.3	%
	800 Hz	0.5	%
	1600 Hz	0.7	%
Telecoil sensitivity (SPLIV @ 31.6 mA/m)		90	dB SPL
Equivalent input noise (w/o noise reduction)		23	dB SPL
Frequency range (DIN 45605)		100–7060	Hz
Current drain (in test mode)		1.3	mA

Note: Telecoil sensitivity only applicable for 62 RIE models

Data in accordance with IEC60118-0 Edition3.0 2015-06, IEC60118-7 and ANSI S3.22-2009, supply Voltage 1.3V

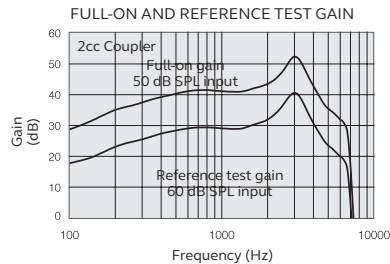
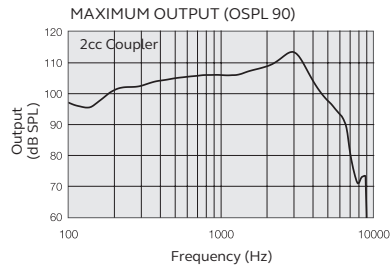

RIE - MP receiver

Models: LT962-DRW, LT762-DRW, LT562-DRW
LT961-DRW, LT761-DRW, LT561-DRW

Reference test gain (60 dB SPL input)	HFA	37	dB
Full-on gain (50 dB SPL Input)	Max	58	dB
	HFA	51	dB
Maximum output (90 dB SPL input)	Max	116	dB SPL
	HFA	114	dB SPL
Total harmonic distortion	500 Hz	0.5	%
	800 Hz	0.6	%
	1600 Hz	1.2	%
Telecoil sensitivity (SPLIV @ 31.6 mA/m)		96	dB SPL
Equivalent input noise (w/o noise reduction)		23	dB SPL
Frequency range (DIN 45605)		100–7000	Hz
Current drain (in test mode)		1.3	mA

Note: Telecoil sensitivity only applicable for 62 RIE models

Data in accordance with IEC60118-0 Edition3.0 2015-06, IEC60118-7 and ANSI S3.22-2009, supply Voltage 1.3V

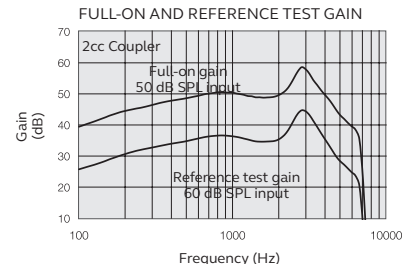
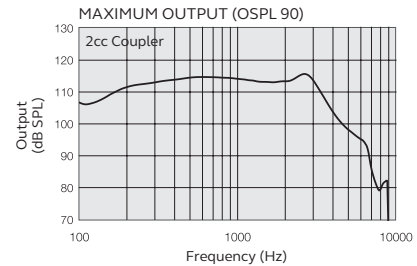

RIE - HP receiver

Models: LT962-DRW, LT762-DRW, LT562-DRW
LT961-DRW, LT761-DRW, LT561-DRW

Reference test gain (60 dB SPL input)	HFA	42	dB
Full-on gain (50 dB SPL Input)	Max	65	dB
	HFA	56	dB
Maximum output (90 dB SPL input)	Max	122	dB SPL
	HFA	118	dB SPL
Total harmonic distortion	500 Hz	0.6	%
	800 Hz	1.2	%
	1600 Hz	0.7	%
Telecoil sensitivity (SPLIV @ 31.6 mA/m)		101	dB SPL
Equivalent input noise (w/o noise reduction)		23	dB SPL
Frequency range (DIN 45605)		100–6030	Hz
Current drain (in test mode)		1.3	mA

Note: Telecoil sensitivity only applicable for 62 RIE models

Data in accordance with IEC60118-0 Edition3.0 2015-06, IEC60118-7 and ANSI S3.22-2009, supply Voltage 1.3V

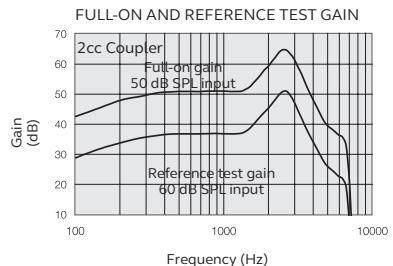
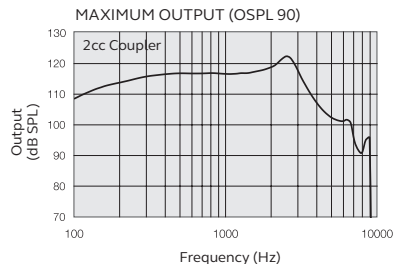

RIE - UP receiver

Models: LT962-DRW, LT762-DRW, LT562-DRW
LT961-DRW, LT761-DRW, LT561-DRW

Reference test gain (60 dB SPL input)	HFA	47	dB
Full-on gain (50 dB SPL Input)	Max	75	dB
	HFA	64	dB
Maximum output (90 dB SPL input)	Max	129	dB SPL
	HFA	124	dB SPL
Total harmonic distortion	500 Hz	1.3	%
	800 Hz	2.1	%
	1600 Hz	0.1	%
Telecoil sensitivity (SPLIV @ 31.6 mA/m)		107	dB SPL
Equivalent input noise (w/o noise reduction)		23	dB SPL
Frequency range (DIN 45605)		100–4910	Hz
Current drain (in test mode)		1.2	mA

Note: Telecoil sensitivity only applicable for 62 RIE models

Data in accordance with IEC60118-0 Edition3.0 2015-06, IEC60118-7 and ANSI S3.22-2009, supply Voltage 1.3V

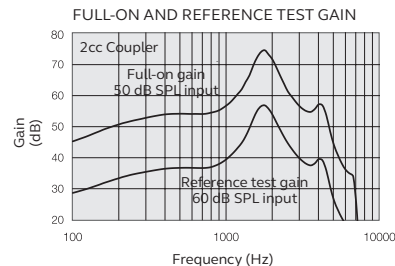
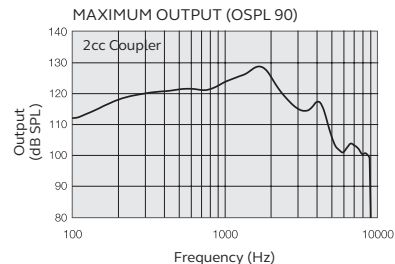

26 Troubleshooting guide

SYMPTOM	CAUSE	POSSIBLE REMEDY
Feedback, “whistling”	Is your earmould or dome inserted correctly?	Put it in again.
	Is the volume very loud?	Reduce it.
	Is the plastic tube or the earmould clogged or broken?	Replace or visit your hearing care professional.
	Are you holding an object (e.g. a hat, a telephone receiver) close to a hearing aid?	Move your hand away to create more space between the hearing aid and the object.
	Is your ear full of wax?	Visit your physician.
No sound	Is the hearing aid turned on?	Switch it on.
	Is the hearing aid in telecoil mode?	Switch to the microphone program.
	Is there a battery in the hearing aid?	Insert a new battery.
	Is the battery still good?	Replace with a new one.
	Is the plastic tube or the earmould clogged or broken?	Visit your hearing care practitioner.
	Is your ear full of wax?	Visit your physician.

SYMPTOM	CAUSE	POSSIBLE REMEDY
Sound is distorted, spluttering or weak?	Is the battery dead?	Replace it with a new one.
	Is the battery dirty?	Clean it or replace it with a new one.
	Is the plastic tube or the earmould clogged or broken?	Visit your hearing care professional.
	Did your hearing aid get moist?	Use a desiccant.
Battery drains very quickly	Did you leave your hearing aid switched on for long periods of time?	Always switch off your hearing aid when you are not using them, e.g. during the night.
	Is the battery old?	Check the date on the battery packaging.

27 Warranties and repairs

ReSound provides a warranty on hearing aids in the event of defects in workmanship or materials, as described in applicable warranty documentation. In its service policy, ReSound pledges to secure functionality at least equivalent to the original hearing aid. As a signatory to the United Nations Global Compact initiative, ReSound is committed to doing this in line with environment-friendly best practices. Hearing aids therefore, at ReSound's discretion, may be replaced by new products or products manufactured from new or serviceable used parts, or repaired using new or refurbished replacement parts. The warranty period of hearing aids is designated on your warranty card, which is provided by your hearing care professional.

For hearing aids that require service, please contact your hearing care professional for assistance. ReSound hearing aids that malfunction must be repaired by a qualified technician. Do not attempt to open the case of hearing aids, as this will invalidate the warranty.

28 Temperature test, transport and storage information

ReSound hearing aids are subjected to various tests in temperature and damp heating cycling between -25 °C and +70 °C according to internal and industry standards.

During transport or storage, the temperature should not exceed the limit values of -20 °C to +60 °C and relative humidity of 90% RH, non-condensing (for limited time). The air pressure between 500 and 1100 hPa is appropriate.

Be aware of information marked with the warning symbol:



WARNING points out a situation that could lead to serious injuries.



CAUTION indicates a situation that could lead to minor and moderate injuries.



Advice and tips on how to handle your hearing aid better.



Equipment includes RF transmitter

ReSound LiNX 3D is compatible with iPhone 8 Plus, iPhone 8, iPhone 7 Plus, iPhone 7, iPhone 6s Plus, iPhone 6s, iPhone 6 Plus, iPhone 6, iPhone SE, iPhone 5s, iPhone 5c, iPhone 5, iPad Pro (10.5-inch), iPad Pro (12.9-inch), iPad Pro (9.7-inch), iPad Air 2, iPad Air, iPad mini 4, iPad mini 3, iPad mini 2, iPad mini, iPad (5th generation), iPad (4th generation), iPod touch (6th generation) and iPod touch (5th generation) using iOS 8.0 or later. Apple, the Apple logo, iPhone, iPad Pro, iPad Air, iPad mini, iPad and iPod touch are trademarks of Apple Inc., registered in the U.S. and other countries.



“Made for iPod/iPhone/iPad” means that an electronic accessory has been designed to connect to iPhone, iPad, and iPod models and has been certified by the developer to meet Apple performance standards. Apple is not responsible for the operation of this device or its compliance with safety and regulatory standards. Please note that the use of this accessory with iPhone, iPad or iPod may affect wireless performance.



Please ask your local hearing care professional concerning disposal of your hearing aid

Portions of this software are written by Kenneth MacKay (micro-ecc) and licensed under the following terms and conditions:

Copyright © 2014, Kenneth MacKay. All rights reserved.

Redistribution and use in source and binary forms, with or without modification, are permitted provided that the following conditions are met:

- * Redistributions of source code must retain the above copyright notice, this list of conditions and the following disclaimer.
- * Redistributions in binary form must reproduce the above copyright notice, this list of conditions and the following disclaimer in the documentation and/or other materials provided with the distribution.

THIS SOFTWARE IS PROVIDED BY THE COPYRIGHT HOLDERS AND CONTRIBUTORS “AS IS” AND ANY EXPRESS OR IMPLIED WARRANTIES, INCLUDING, BUT NOT LIMITED TO, THE IMPLIED WARRANTIES OF MERCHANTABILITY AND FITNESS FOR A PARTICULAR PURPOSE ARE DISCLAIMED. IN NO EVENT SHALL THE COPYRIGHT HOLDER OR CONTRIBUTORS BE LIABLE FOR ANY DIRECT, INDIRECT, INCIDENTAL, SPECIAL, EXEMPLARY, OR CONSEQUENTIAL DAMAGES (INCLUDING, BUT NOT LIMITED TO, PROCUREMENT OF SUBSTITUTE GOODS OR SERVICES; LOSS OF USE, DATA, OR PROFITS; OR BUSINESS INTERRUPTION) HOWEVER CAUSED AND ON ANY THEORY OF LIABILITY, WHETHER IN CONTRACT, STRICT LIABILITY, OR TORT (INCLUDING NEGLIGENCE OR OTHERWISE) ARISING IN ANY WAY OUT OF THE USE OF THIS SOFTWARE, EVEN IF ADVISED OF THE POSSIBILITY OF SUCH DAMAGE.

Manufacturer according to EU Medical Device
Directive 93/42/EEC:

Worldwide Headquarters

GN ReSound A/S
Lautrupbjerg 7
DK-2750 Ballerup
Denmark
Tel.: +45 4575 1111
resound.com

United Kingdom

GN Hearing UK Ltd.
Kirtlington Business Centre
Portway, Kirtlington
Oxon OX5 3JA
Tel.: +44 1869 352 800
resound.com

Australia

GN Hearing Australia Pty. Ltd.
Gate C, 19-25 Khartoum Road
Macquarie Technology Park
Macquarie Park NSW 2113
Tel.: (free) 1800 658 955
resound.com

CVR no. 55082715

New Zealand

GN Hearing NZ Ltd.
Ground Floor, North Entrance
4 Fred Thomas Drive
Takapuna, Auckland, 0622
Tel.: (free) 0800 900 126
resound.com

Singapore

GN Hearing Pte. Ltd.
2 Kallang Avenue
#07-19 CT HUB
Singapore - 339407
Tel.: +65 6320 9388
resound.com



Any issues relating to the EU Medical Device Directive 93/42/EEC or EU Radio
Equipment Directive 2014/53/EU should be directed to GN ReSound A/S

